

TESIRAFORTÉ®

biamp.





The TesiraFORTÉ® family offers four different models. Each TesiraFORTÉ model is designed and optimized to address a different business challenge, with an eye towards accommodating advancements in AV technologies.

Because some applications don't require audio networking, each model is available in an AVB, non-AVB, or Dante™ compatible version. All versions include the same full set of features; the only difference is the ability to transport audio using AVB/TSN or Dante. The Dante-equipped models allow for interfacing with the Shure® MXA beamforming microphones.

Audio Video Bridging/Time Sensitive Networking (AVB/TSN) is a set of open IEEE standards that have been adopted across multiple industries, including the automotive and industrial sectors, and by major companies such as Intel® and Cisco®. With an AVB/TSN backbone, media streams can travel throughout your facility over the corporate network.

Tesira AVB audio devices are Avnu™ certified. This is a significant milestone, and demonstrates Biamp's commitment to supporting the adoption of AVB/TSN by providing customers with future-proofed, robust networked media solutions. The Avnu Alliance provides certifications for member products that meet all requirements set forth by the Avnu Certified Logo Program.

By selecting TesiraFORTÉ, you're choosing a smarter, more efficient audio solution for your customers, and one that will last them long into the future.

FOR THE LOVE OF SOUND™

AVB DSP WITH USB AUDIO.

To enhance the functionality and flexibility of TesiraFORTÉ, we added a USB port to each model. The port can interface directly with third-party technologies, allowing you to take full advantage of today's most sophisticated conferencing solutions. Here are a few applications where you may want to consider using USB audio:

CONFERENCING | Connect directly with a soft codec device

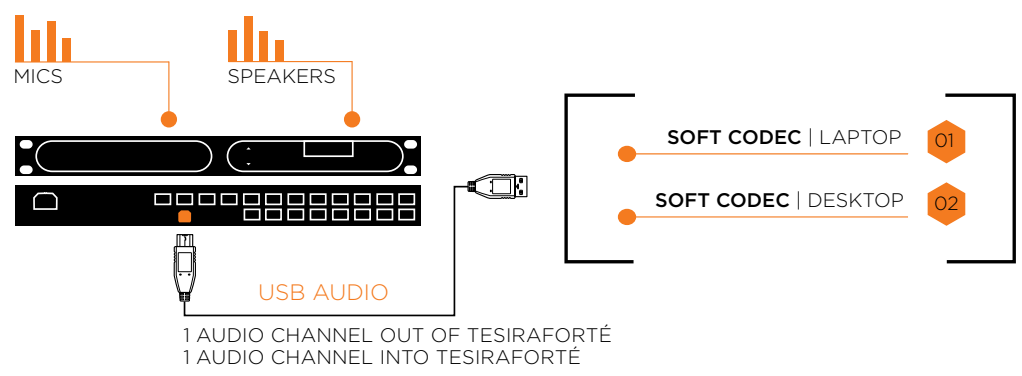

CUTTING EDGE, ANYONE?

Each TesiraFORTÉ model supports up to 8 channels of configurable audio I/O that can be allocated in the programming interface. With multiple combinations of inputs and outputs, transporting audio over USB makes TesiraFORTÉ a powerful solution for a number of common business challenges.

BACKGROUND MUSIC | Receive digital audio directly from a music source

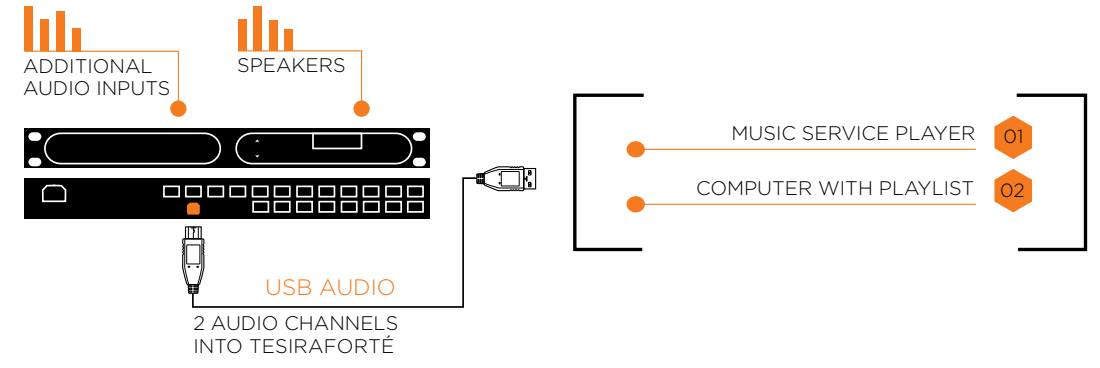

COURT RECORDING | Interface directly with court recording devices

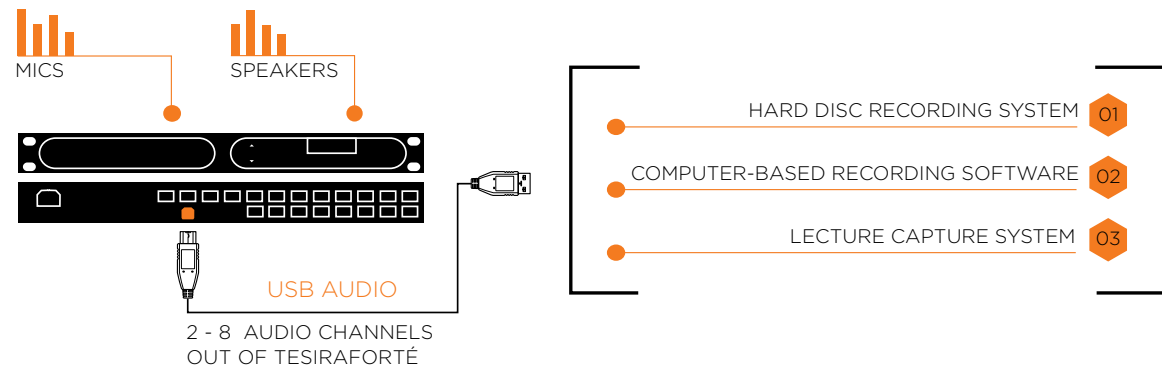

LECTURE/MEETING RECORDING | Interface directly with recording devices

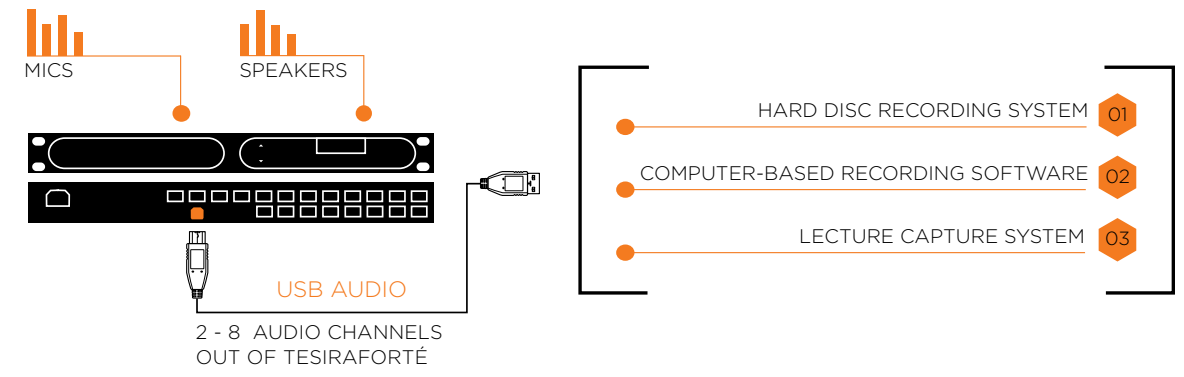

WHY ARE THERE SO MANY TesiraFORTÉ'S?

BECAUSE YOU SHOULDN'T HAVE TO PAY FOR FUNCTIONALITY YOU DON'T NEED

That's the answer in a nutshell. Some audio DSP platforms perform best in non-networked spaces, while others do better in distributed, networked installations. TesiraFORTÉ lets you decide what's right for your project and budget.

HERE ARE THE SPECIFIC FEATURES OF EACH MODEL:

TesiraFORTÉ AI: Standard Model for High-Quality Audio

- 128 x 128 network channels (AVB model only)
- 32 x 32 network channels (DAN model only)
- 12 mic/line level inputs, 8 mic/line level outputs
- Gigabit Ethernet control port
- RS-232 serial port
- Up to 8 channels of configurable USB audio
- 4-pin GPIO
- 2-line OLED display with capacitive-touch navigation
- Rack mountable (1RU)
- Internal universal power supply
- Tesira server-class device

TesiraFORTÉ CI: External Codec Conferencing Solution

- Includes all features of the standard AI model, plus AEC technology on all 12 inputs

TesiraFORTÉ TI: Conferencing over Standard Telephone Service Solution

- Includes all features of the standard AI model, plus AEC technology on all 12 inputs and standard telephone interface via an RJ-11 input connector

TesiraFORTÉ VI: VoIP Conferencing Solution

- Includes all features of the standard AI model, plus AEC technology on all 12 inputs and VoIP connectivity via an RJ-45 input connector



TesiraFORTÉ AI

STANDARD MODEL FOR HIGH-QUALITY AUDIO

At its best in conference rooms or council chambers, the sweet spot for the AI model is installations requiring high-quality audio solutions such as those with voice lift and mix-minus.

For those customers who want to link multiple rooms together for centralized control, or add them to an existing Tesira AVB network, TesiraFORTÉ AVB AI models are the right choice for general audio applications.

The TesiraFORTÉ AI and DAN AI are better choices for those environments where a standalone DSP is needed for localized audio per room.

TesiraFORTÉ CI

EXTERNAL CODEC CONFERENCING SOLUTION

Soft codec conferencing is the way the world does business, and TesiraFORTÉ CI is the ideal model to help you get the most from this technology. By passing all audio signals through a powerful DSP that's built to make sure every word is heard, you get the best of both worlds.

With the USB port enabling direct integration with soft codec technologies, and AEC technology ensuring superior conferencing audio, all TesiraFORTÉ CI models are built for truly collaborative communications.



TesiraFORTÉ TI

CONFERENCING OVER STANDARD TELEPHONE SERVICE SOLUTION

The TesiraFORTÉ TI models are built to provide specialized conferencing capabilities using standard telephone service. For those customers who conference over analog telephone lines, the TI model is a cost-effective solution that provides quality audio in conference rooms, without having to pay the cost of reconstructing existing infrastructure.

Whether you plan to link multiple rooms together, add them to an existing Tesira AVB network, or keep the units separate, the TI models facilitate broad communication over standard telephone lines and leverage AEC.

TesiraFORTÉ VI

VOIP CONFERENCING SOLUTION

Equipped with AEC and VoIP technologies, the TesiraFORTÉ VI models were born for conferencing. Audio solutions using VoIP can be challenging, complex, and time-consuming to design and install. With the VI, VoIP teleconferencing has never been easier.

We've leveraged our years of experience creating high-quality VoIP solutions to bring you the VI model for high-level VoIP teleconferencing. Having the USB port and VoIP capabilities gives you two options for conferencing, and even more ways to manage your network.



PRODUCTS



SERVER-CLASS DEVICES

FIXED AUDIO*

TesiraFORTÉ AVB AI	Fixed I/O configuration of 12 mic/line level inputs and 8 mic/line level outputs. Supports up to 8 channels of configurable USB audio.
TesiraFORTÉ AVB CI	Fixed I/O configuration of 12 mic/line level inputs with AEC and 8 mic/line level outputs. Supports up to 8 channels of configurable USB audio.
TesiraFORTÉ AVB TI	Fixed I/O configuration of 12 mic/line level inputs with AEC, 8 mic/line level outputs, and 1 channel of analog telephony. Supports up to 8 channels of configurable USB audio.
TesiraFORTÉ AVB VI	Fixed I/O configuration of 12 mic/line level inputs with AEC, 8 mic/line level outputs, and 2 channels of VoIP telephony. Supports up to 8 channels of configurable USB audio.

FIXED VIDEO

TesiraLUX IDH-1	AVB video encoder; includes one HDMI® port and one DisplayPort™ 1.2 port. Accepts 8 channels of embedded PCM audio and includes 2 mic/line level analog inputs.
TesiraLUX OH-1	AVB video decoder; includes one HDMI port. Outputs 8 channels of embedded PCM audio and includes 2 mic/line level analog outputs.

CONTROLS

CONTROLS

TEC-1s	PoE Ethernet control – surface mount
TEC-1i	PoE Ethernet control - in-wall mount
EX-LOGIC	PoE controller with 16 logic GPIO
HD-1	Hardware dialer with 12-key standard dial pad and 4 navigation buttons
Oreno	Mobile control software for Tesira-equipped rooms

* Dante-enabled models, as well as non-networked models, are also available.

ENDPOINTS AND EXPANDERS

ENDPOINTS

AMP-4175R	4-channel, 175W, supports optional I/O card
AMP-8175R	8-channel, 175W, supports 2 optional I/O cards
AMP-4350R	4-channel, 350W, supports optional I/O card
AMP-4300R CV	4-channel, 300W, constant voltage, supports optional I/O card
AMP-A460H	4-channel, 60W amplifier

ENDPOINT EXPANDER CARDS

EIC-4	4-channel mic/line input card
EOC-4	4-channel mic/line output card
EIOC-4	2-channel mic/line input and 2-channel mic/line output card

EXPANDERS*

EX-IN	PoE+ 4-channel mic/line input expander
EX-AEC	PoE+ 4-channel mic/line input expander with AEC
EX-OUT	PoE+ 4-channel mic/line output expander
EX-IO	PoE+ 2-channel mic/line input and 2-channel mic/line output expander
EX-MOD	Modular expander that can be configured with up to three I/O cards

EX-MOD EXPANDER CARDS

EIC-4	4-channel mic/line input card
EEC-4	4-channel mic/line input card with AEC
EOC-4	4-channel mic/line output card
EIOC-4	2-channel mic/line input and 2-channel mic/line output card

* Expanders are only compatible with TesiraFORTÉ AVB-enabled models.



biamp.com/training

Our Technical Support team has won accolades for the high level of service they provide to our customers day in and day out. With unparalleled worldwide support, Biamp's applications engineers walk you through solutions, and assist you with new system designs, programming, or troubleshooting.

They also perform our in-person and online equipment and concept trainings. From webinars and tutorials on YouTube®, to articles and tech notes on Cornerstone—our online technical support knowledgebase—to in-person multi-day certification trainings, Biamp has invested in your success.

TesiraFORTÉ is backed by our 5-year warranty. Training is available online and as part of the in-person Tesira certification training course. To learn more about upcoming courses, including schedules, go to biamp.com/training.

WHEN
YOU
NEED
TRAINING
AND
SUPPORT,
WE'VE
GOT
YOUR
BACK.

Biamp, Tesira and TesiraFORTÉ are either trademarks or registered trademarks of Biamp Systems Corporation in the United States and other countries. Other product names referenced may be trademarks or registered marks of their respective owners and Biamp Systems is not affiliated with or sponsored by these companies. Dante and its logotypes is a trademark of Audinate Pty Ltd.



CONTACT US:

**9300 S.W. Gemini Dr.
Beaverton, OR 97008
USA**

**E: biampinfo@biamp.com
W: biamp.com**

**1.800.826.1457
+ 1.503.641.7287**



biamp.

TESIRA[®] PRODUCT CATALOG

PRODUCT OFFERINGS
EFFECTIVE FEBRUARY 2017



CONTENTS

03 TESIRA SYSTEM OVERVIEW

SERVER-CLASS DEVICES

04 CONFIGURABLE AUDIO

06 CONFIGURABLE AUDIO CARDS

10 FIXED AUDIO

12 FIXED VIDEO

ENDPOINTS, EXPANDERS, AND MORE

14 ENDPOINTS

16 ENDPOINT EXPANDER CARDS

18 EXPANDERS

20 EXPANDER CARDS

21 MICROPHONES

22 CONTROLS

25 DESIGN SOFTWARE

26 CONTACT US

THE POWER OF THE PLATFORM



As Biamp's flagship audio and video platform, Tesira® is a true Networked Media System. Tesira is the first truly scalable media system for digital audio and video networking using AVB/TSN.

SERVER-CLASS DEVICES

Tesira SERVER and SERVER-IO are configurable audio servers. Tesira SERVER is built for maximum flexibility, and also allows you to build out the rest of your system using expanders, making it a cost-effective choice while supporting future growth. Tesira SERVER-IO is easily configurable, and allows you to leverage VoIP while networking multiple rooms together over AVB.

TesiraFORTÉ products are fixed audio servers available in four different models optimized for specific applications. All models are well-suited for many applications, from background music to court recording to soft codec integration. TesiraFORTÉ directly connects to soft codec technologies via its USB port, and supports distance conferencing over VoIP and analog telephony devices.

Rounding out the Tesira platform are the TesiraLUX fixed video servers. TesiraLUX fully integrates digital audio and video on a single network, allowing for simplified lip sync management and end-to-end network transit latencies of less than 2 frames. TesiraLUX is a great choice for installations that require low latency, high-quality, synchronized media distribution.

EXPANDERS

Tesira's half-rack expanders are compatible with Tesira server-class audio devices, and provide 4 channels powered by PoE+. The EX-MOD device offers remote placement of input and output capabilities. All Tesira expanders communicate with the Tesira AVB network for audio networking, configuration, and control.

ENDPOINTS

Tesira amplifiers let you create a more complete audio system that can be designed and commissioned from one software platform. Adding amplifier blocks to your design files is a simple drag-and-drop.

CONTROL OPTIONS

Oreno® mobile control software brings control of Tesira-equipped rooms to handheld devices. The HD-1 dialer provides innovative features and a traditional keypad to installations. Tesira surface-mounted and in-wall remote Ethernet control devices can be configured to fit the needs of a particular application.

SOFTWARE

Tesira's design software will help you minimize design and installation time and lower costs. Biamp Canvas® software allows efficient creation and use of customized control screens with Tesira digital audio systems.



SERVER-CLASS DEVICES

CONFIGURABLE AUDIO



TESIRA SERVER

The Tesira SERVER is a digital network server. It is factory configured with one DSP-2 card and can accept up to a total of eight DSP-2 cards. The SERVER is also factory configured with one AVB-1 card and has a second slot that can be outfitted with an additional AVB-1 card, a 32 x 32 channel SCM-1 CobraNet card, a 64 x 64 channel DAN-1 Dante™ card; or a standard I/O card for four channels of local I/O. The SERVER is the core of a Tesira digital audio system and can be used with Tesira expanders to form a highly scalable audio network. Two Tesira SERVERs can also be designed as a redundant pair, carrying identical processing and card configurations. The secondary SERVER stays 'live' with the primary, updating runtime parameters. If the primary SERVER should need maintenance, the secondary takes over with no loss of continuity or downtime.

- › Supports up to eight DSP-2 cards
- › Up to 420 x 420 channels of digital I/O over AVB
- › Optional 32 x 32 CobraNet audio networking
- › Optional 64 x 64 Dante audio networking
- › Configuration and control networking over Ethernet
- › Supports redundant processing pairs
- › Local GPIO connections
- › Front panel OLED display for device and system information
- › Processing algorithm: SpeechSense
- › Signal processing via intuitive software allows configuration and control for: signal routing and mixing, equalization, filtering, dynamics and delay, and much more
- › Extensive expansion devices (input, output, logic, etc.) available as part of the Tesira digital audio networking platform
- › Rack mountable (3RU)
- › CE marked, UL listed, RoHS compliant
- › Covered by Biamp Systems' five-year warranty



TESIRA SERVER-IO

The Tesira SERVER-IO is a digital network server. It is factory configured with one DSP-2 card and is capable of handling up to two additional DSP-2 cards. The SERVER-IO has capacity for up to three total audio networking cards per server. The combinations of networking cards can include up to two AVB-1 Audio Video Bridging network cards, up to two SCM-1 CobraNet network cards, and up to two DAN-1 Dante network cards in any configuration. The SERVER-IO can support up to 12 standard Tesira I/O cards for up to 48 channels of audio I/O (e.g. mic and line level, VoIP, and telephone interface). The SERVER-IO can be used as a standalone or with Tesira expanders to form a highly scalable audio network.

- › Supports up to three DSP-2 cards
- › Up to 12 I/O cards with a maximum of 48 channels of audio
- › Up to 420 x 420 channels of digital I/O over AVB
- › Optional 32 x 32 CobraNet audio networking
- › Optional 64 x 64 Dante audio networking
- › Configuration and control networking over Ethernet
- › Supports network redundancy
- › Local GPIO connections
- › Front panel OLED display for device and system information
- › Processing algorithm: SpeechSense
- › Signal processing via intuitive software allows configuration and control for: signal routing and mixing, equalization, filtering, dynamics and delay, and much more
- › Wide selection of I/O cards available
- › 4-channel Acoustic Echo Cancellation card (also includes AGC and ANC) and Ambient Noise Compensation card available
- › Extensive expansion devices (input, output, logic, etc.) available as part of the Tesira digital audio networking platform
- › Rack mountable (3RU)
- › CE marked, UL listed, RoHS compliant
- › Covered by Biamp Systems' five-year warranty



SERVER-CLASS DEVICES

CONFIGURABLE AUDIO CARDS

TESIRA AVB-1



The Tesira AVB-1 is a modular digital audio networking card for use with Tesira SERVER and SERVER-IO devices. The AVB-1 allows a Tesira system to send and receive digital audio over an Ethernet network utilizing AVB enabled switches. AVB/TSN (Audio Video Bridging/Time Sensitive Networking) is an open standard protocol compliant with IEEE standards. In addition to allowing up to 420 x 420 channels of interconnectivity over AVB from any other compliant device, Tesira uses AVB/TSN as the interconnect between server devices and remote expander devices.

- › Up to 420 x 420 channels of digital I/O over AVB
- › Very low network latencies
- › Media and control data managed on a single network
- › Covered by Biamp Systems' five-year warranty
- › IEEE Standards based
 - 802.1AS
 - 802.1Qav
 - 802.1Qat
 - 1722
 - 1722.1

TESIRA DSP-2



The Tesira DSP-2 card is a modular digital signal processing card for use with Tesira SERVER and SERVER-IO devices. DSP-2 cards add extra resources and processing power to a Tesira system. As the necessary processing increases for larger systems, DSP-2 cards can be added in the field or at the Biamp factory. The Tesira SERVER can accommodate up to eight DSP-2 cards while SERVER-IO can support up to three.

- › Adds additional processing power to Tesira systems
- › Each DSP-2 card has the power of one AudiaFLEX
- › DSP resources managed via Tesira software systems
- › RoHS compliant
- › Covered by Biamp Systems' five-year warranty

TESIRA DAN-1



The Tesira DAN-1 is an optional digital audio networking card for Tesira SERVER or SERVER-IO and allows for interface to other audio devices utilizing Dante networking protocol from Audinate®. The DAN-1 card can be factory installed or installed in the field. Featuring the Brooklyn II Module, the DAN-1 allows for up to 64 x 64 channels of digital audio into and out of a Tesira system. This interface takes full advantage of the Tesira platform while interfacing to devices that are equipped with Dante networking.

- › 64 x 64 channels of Dante
- › Dual RJ-45 connections for Primary and Secondary
- › Up to 32 x 32 simultaneous flows
- › Explicit Dante Input and Output blocks in Tesira Software
- › Can be installed in conjunction with AVB-1 and SCM-1
- › System configuration and control via Ethernet
- › Covered by Biamp Systems' five-year warranty

TESIRA SIC-4

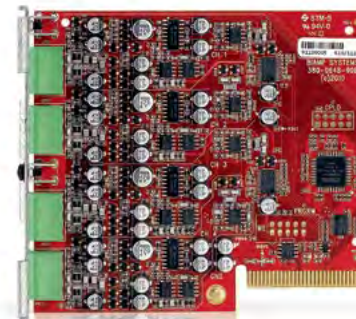

The Tesira SIC-4 is a modular analog input card for use with Tesira SERVER and SERVER-IO devices. Each SIC-4 provides four channels of mic or line level audio input. The inputs are electrically balanced and provided on plug-in barrier strip connectors. Software control of each input includes gain with clip indicator, +48V phantom power, mute, level, and signal invert.

- › Four channels of balanced mic or line level input
- › Plug-in barrier strip connectors
- › 0 – 66dB gain, adjustable in 6dB increments
- › Clip indicator
- › +48V Phantom Power
- › 100 to +12dB fader range for level
- › Signal invert for reverse polarity
- › RoHS compliant and AES grounded
- › Covered by Biamp Systems' five-year warranty

TESIRA SCM-1



The Tesira SCM-1 is a modular digital audio networking card for use with Tesira SERVER and SERVER-IO devices. The SCM-1 allows a Tesira system to send and receive digital audio using the CobraNet networking standard. Each SCM-1 CobraNet card allows for interconnectivity of 32 x 32 channels of digital audio. Implementing the SCM-1 allows a Tesira system to share audio with Biamp Audia® and Vocia® systems as well as other devices operating on a CobraNet network.

- › 32 x 32 channels of digital audio interconnectivity
- › Allows for sharing of digital audio with Audia and Vocia systems
- › Covered by Biamp Systems' five-year warranty

TESIRA SOC-4



The Tesira SOC-4 is a modular analog output card for use with Tesira SERVER and SERVER-IO devices. Each SOC-4 provides four channels of mic or line level audio output. The outputs are electrically balanced and provided on plug-in barrier strip connectors. Software control of each output includes mute, level, signal invert, and full-scale output reference.

- › Four channels of balanced mic or line level output
- › Plug-in barrier strip connectors
- › -100 to +12dB fader range for level
- › Signal invert for reverse polarity
- › Selectable full-scale output reference level (24dBu, 18dBu, 12dBu, 6dBu, 0dBu, -31dBu) for best interface/performance
- › RoHS compliant and AES grounded
- › Covered by Biamp Systems' five-year warranty

SERVER-CLASS DEVICES

CONFIGURABLE AUDIO CARDS

TESIRA SEC-4

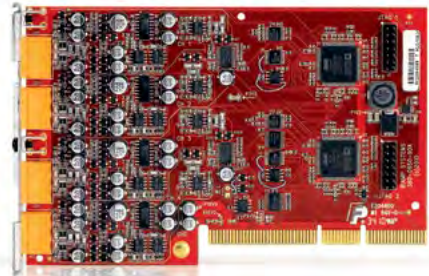

The Tesira SEC-4 is a modular analog input card for use with Tesira SERVER and SERVER-IO devices. Each SEC-4 provides four channels of mic or line level audio input with Acoustic Echo Cancellation and also features Biamp SpeechSense technology, which enhances speech processing by more accurately identifying human speech.

- › Four channels of balanced mic or line level input with AEC (Acoustic Echo Cancellation)
- › SpeechSense processing algorithm
- › Processing includes High-Pass Filter
- › Additional noise reduction on AEC outputs
- › Doesn't use processing resources from SERVER or SERVER-IO DSP
- › RoHS compliant and AES grounded
- › Covered by Biamp Systems' five-year warranty

TESIRA SAC-4

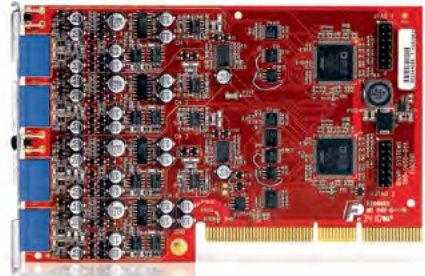

The Tesira SAC-4 is a modular analog input card for use with Tesira SERVER and SERVER-IO devices. Each SAC-4 provides four channels of mic or line level audio input with Ambient Noise Compensation. The ANC processing features the Biamp algorithm, AmbientSense, which intelligently distinguishes ambient noise from program material or announcements, thus greatly improving performance over traditional ambient noise compensation.

- › Four channels of balanced mic or line level input
- › Four channels of Ambient Noise Compensation using Biamp's proprietary AmbientSense algorithm
- › Automatically adjusts levels for program material or announcements, based on changes in ambient level
- › Up to four "sense" inputs per card
- › Does not use processing resources from SERVER or SERVER-IO DSP
- › RoHS compliant and AES grounded
- › Covered by Biamp Systems' five-year warranty

TESIRA SVC-2



The Tesira SVC-2 is a modular Voice over Internet Protocol (VoIP) card for use with Tesira SERVER and SERVER-IO devices. The SVC-2 allows a Tesira system to connect directly to IP-based telephone systems. When used in conjunction with Acoustic Echo Cancellation (AEC) processing, Tesira becomes a powerful, flexible, and affordable conferencing platform.

- › Control via Tesira software or third-party control
- › Logic control within Tesira or RCB devices
- › Caller ID, Hold capability, Redial, 16-entry Speed Dial
- › Adjustable auto-answer
- › Country-specific tone plans
- › SIP v2 (RFC 3261 and companion RFCs)
- › SIP authentication
- › Voice activity detection
- › On-hook dialing
- › Multiple CODEC support
- › RoHS compliant
- › Covered by Biamp Systems' five-year warranty

TESIRA STC-2



The Tesira STC-2 is a modular telephone interface card for use with Tesira SERVER and SERVER-IO devices. The STC-2 allows a Tesira system to connect directly to standard analog telephone lines. Each channel includes line-echo cancellation, noise suppression, caller ID decoding, ring detection/validation, DTMF decoding, and call progress tone decoding. When used in conjunction with Acoustic Echo Cancellation (AEC) processing, Tesira becomes a powerful, flexible, and affordable conferencing platform.

- › Initiate outgoing calls
 - DTMF tone dialing - Redial
 - Speed-dialing - Flash
- › Detect and answer incoming calls
- › Line echo cancellation
- › TouchTone™ decoding Caller ID reception
- › Call progress detection
- › Line intrusion detection
- › Noise suppression filter
- › Continuous line status and fault monitoring
- › RoHS compliant and AES grounded
- › Covered by Biamp Systems' five-year warranty

SERVER-CLASS DEVICES

FIXED AUDIO



TESIRAFORTÉ AI

The TesiraFORTÉ AI is a digital audio server with 12 analog inputs and 8 analog outputs, and includes up to 8 channels of configurable USB audio. TesiraFORTÉ AVB AI adds AVB/TSN digital audio networking. The AVB model can be used as a standalone device or can be combined with other TesiraFORTÉ devices and Tesira servers, expanders, endpoints, and controllers. TesiraFORTÉ DAN AI adds Dante digital audio networking.

- › 128 x 128 channels of AVB (AVB model only)
- › 32 x 32 channels of Dante (DAN model only)
- › 12 mic/line level inputs, 8 mic/line level outputs
- › Gigabit Ethernet port
- › RS-232 serial port
- › 4-pin GPIO
- › 2-line OLED display with capacitive-touch navigation
- › Rack mountable (IRU)
- › System configuration and control via Ethernet
- › Internal universal power supply
- › Signal processing via intuitive software allows configuration and control for signal routing, mixing, equalization, filtering, and delay
- › CE marked, UL listed, and RoHS compliant
- › Covered by Biamp Systems' five-year warranty



(AVB Model Shown)



TESIRAFORTÉ CI

The TesiraFORTÉ CI is a digital audio server with 12 analog inputs and 8 analog outputs, and includes Acoustic Echo Cancellation (AEC) technology on all 12 inputs. It also includes up to 8 channels of configurable USB audio. TesiraFORTÉ AVB CI adds AVB/TSN digital audio networking. The AVB model can be used as a standalone device or can be combined with other TesiraFORTÉ devices and Tesira servers, expanders, endpoints, and controllers. TesiraFORTÉ DAN CI adds Dante digital audio networking.

- › 128 x 128 channels of AVB (AVB model only)
- › 32 x 32 channels of Dante (DAN model only)
- › 12 mic/line level inputs with AEC, 8 mic/line level outputs
- › Gigabit Ethernet port
- › RS-232 serial port
- › 4-pin GPIO
- › 2-line OLED display with capacitive-touch navigation
- › Rack mountable (IRU)
- › System configuration and control via Ethernet
- › Internal universal power supply
- › Signal processing via intuitive software allows configuration and control for signal routing, mixing, equalization, filtering, and delay
- › CE marked, UL listed, and RoHS compliant
- › Covered by Biamp Systems' five-year warranty



(AVB Model Shown)



TESIRAFORTÉ TI

The TesiraFORTÉ TI is a digital audio server with 12 analog inputs and 8 analog outputs, and includes Acoustic Echo Cancellation (AEC) technology on all 12 inputs. It also includes up to 8 channels of configurable USB audio, and a standard telephone interface via a RJ-11 connector. TesiraFORTÉ AVB TI adds AVB/TSN digital audio networking. The AVB model can be used as a standalone device or can be combined with other TesiraFORTÉ devices and Tesira servers, expanders, endpoints, and controllers. TesiraFORTÉ DAN TI adds Dante digital audio networking.

- › 128 x 128 channels of AVB (AVB model only)
- › 32 x 32 channels of Dante (DAN model only)
- › 12 mic/line level inputs with AEC, 8 mic/line level outputs
- › Gigabit Ethernet port
- › RS-232 serial port
- › 4-pin GPIO
- › 2-line OLED display with capacitive-touch navigation
- › Rack mountable (IRU)
- › System configuration and control via Ethernet
- › Internal universal power supply
- › Standard telephone interface via a RJ-11 connector
- › Signal processing via intuitive software allows configuration and control for signal routing, mixing, equalization, filtering, and delay
- › CE marked, UL listed, and RoHS compliant
- › Covered by Biamp Systems' five-year warranty



(AVB Model Shown)



TESIRAFORTÉ VI

The TesiraFORTÉ VI is a digital audio server with 12 analog inputs and 8 analog outputs, and includes Acoustic Echo Cancellation (AEC) technology on all 12 inputs. It also includes up to 8 channels of configurable USB audio, and a 2-channel VoIP interface via a RJ-45 connector. TesiraFORTÉ AVB VI adds AVB/TSN digital audio networking. The AVB model can be used as a standalone device or can be combined with other TesiraFORTÉ devices and Tesira servers, expanders, endpoints, and controllers. TesiraFORTÉ DAN VI adds Dante digital audio networking.

- › 128 x 128 channels of AVB (AVB model only)
- › 32 x 32 channels of Dante (DAN model only)
- › 12 mic/line level inputs with AEC, 8 mic/line level outputs
- › Gigabit Ethernet port
- › RS-232 serial port
- › 4-pin GPIO
- › 2-line OLED display with capacitive-touch navigation
- › Rack mountable (IRU)
- › System configuration and control via Ethernet
- › Internal universal power supply
- › SIP VoIP interface via a RJ-45 connector
- › Signal processing via intuitive software allows configuration and control for signal routing, mixing, equalization, filtering, and delay
- › CE marked, UL listed, and RoHS compliant
- › Covered by Biamp Systems' five-year warranty



(AVB Model Shown)

SERVER-CLASS DEVICES

FIXED VIDEO



TESIRALUX IDH-1

The TesiraLUX IDH-1 is an AVB/TSN enabled video encoder capable of transmitting video signals up to and including 4K60. The IDH-1 functions as a video server-class device in a Tesira media system and is configured through the Tesira configuration software. Acting as an AVB talker, the IDH-1 fully integrates digital audio and video on a single network, allowing for simplified lip sync management and end-to-end network transit latencies of less than 2 frames. Multiple software-based options are available for managing bandwidth, including setting maximum resolution, frame rate floor, and/or a rate of compression. The AVB/TSN streams can be transmitted over 1Gb or 10Gb ports while control signals are managed via a separate 1Gb Ethernet port. The IDH-1 accepts 8 channels of PCM audio for embedding/de-embedding, and includes 2 mic/line level analog inputs. The TesiraLUX IDH-1 can be used as a standalone device (paired with a TesiraLUX OH-1) or can be combined with other Tesira servers, expanders, endpoints, and controllers.

- › Includes one HDMI® port and one DisplayPort™ 1.2 port
- › Accepts video signals up to and including 4K60
- › Flexible color space including Rec. 2020
- › Supports High Dynamic Range (HDR)
- › Integrated lip sync management
- › Supports 8 channel PCM audio for embedding/de-embedding
- › Automated EDID management between TesiraLUX and the input source
- › Flexible bandwidth management options
- › 2 mic/line level analog audio inputs
- › 4 logic connections can be used as inputs or outputs
- › Optional mounting accessories available
- › CE marked, UL listed, and RoHS compliant
- › Covered by Biamp Systems' five-year warranty



TESIRALUX OH-1

The TesiraLUX OH-1 is an AVB/TSN enabled video decoder capable of outputting video signals up to and including 4K60. The OH-1 functions as a video server-class device in a Tesira media system and is configured through the Tesira configuration software. Acting as an AVB listener, the OH-1 fully integrates digital audio and video on a single network, allowing for simplified lip sync management and end-to-end network transit latencies of less than 2 frames. The AVB/TSN streams can be received over 1Gb or 10Gb ports while control signals are managed via a separate 1Gb Ethernet port. The OH-1 accepts 8 channels of PCM audio for embedding/de-embedding, and includes 2 mic/line level analog outputs. The TesiraLUX OH-1 can be used as a standalone device (paired with a TesiraLUX IDH-1) or can be combined with other Tesira servers, expanders, endpoints, and controllers.

- › Includes one HDMI port
- › Outputs video signals up to and including 4K60
- › Flexible color space including Rec. 2020
- › Supports High Dynamic Range (HDR)
- › Integrated lip sync management
- › Supports 8 channel PCM audio for embedding/de-embedding
- › Video wall capable
- › Automated EDID management between TesiraLUX and the output display
- › 2 mic/line level analog audio outputs
- › 4 logic connections can be used as inputs or outputs
- › Optional mounting accessories available
- › CE marked, UL listed, and RoHS compliant
- › Covered by Biamp Systems' five-year warranty

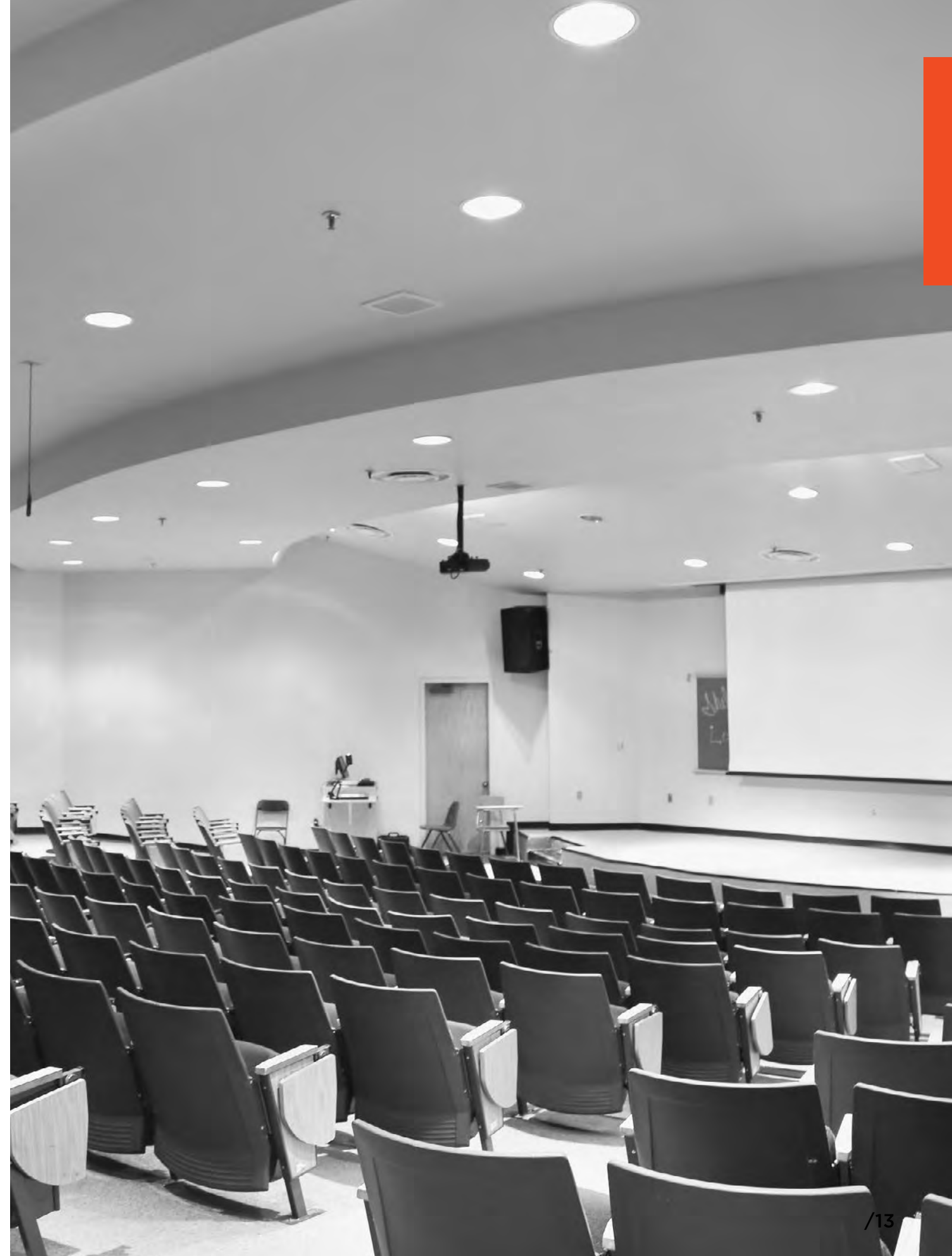

ENDPOINTS



TESIRA AMP-4175R

The Tesira AMP-4175R is a four channel digital networked amplifier. It is AVB/TSN enabled and delivers 175 watts per channel. It is rack mountable and part of an integrated Tesira audio network. It also offers fault reporting, impedance monitoring, and optional analog failover.

- › Four channels; 175W per channel
- › Impedance monitoring
- › Configurable via Tesira software
- › Dual AVB ports
- › Bridgeable channels
- › Optional analog failover
- › Optional I/O expander card slots
- › Front panel OLED display
- › Front panel capacitive touch navigation
- › Front panel control of individual and chassis-wide mutes/levels (defeatable)
- › Rack mountable (2RU)
- › CE marked, UL listed, and RoHS compliant
- › Covered by Biamp Systems' five-year warranty

TESIRA AMP-4300R CV

The Tesira AMP-4300R CV is a four channel digital networked, constant voltage 70V/100V amplifier. It is AVB/TSN enabled and delivers 300 watts per channel. It is rack mountable, and part of an integrated Tesira audio network. It also offers fault reporting, impedance monitoring, and optional analog failover.

- › Four channels; 300W per channel
- › Impedance monitoring
- › Configurable via Tesira software
- › Dual AVB ports
- › Bridgeable channels
- › Optional analog failover
- › Optional I/O expander card slot
- › Front panel OLED display
- › Front panel capacitive touch navigation
- › Front panel control of individual and chassis-wide mutes/levels (defeatable)
- › Rack mountable (2RU)
- › CE marked, UL listed, and RoHS compliant
- › Covered by Biamp Systems' five-year warranty

TESIRA AMP-4350R

The Tesira AMP-4350R is a four channel digital networked amplifier. It is AVB/TSN enabled and delivers 350 watts per channel. It is rack mountable, and part of an integrated Tesira audio network. It also offers fault reporting, impedance monitoring, and optional analog failover.

- › Four channels; 350W per channel
- › Impedance monitoring
- › Configurable via Tesira software
- › Dual AVB ports
- › Bridgeable channels
- › Optional analog failover
- › Optional I/O expander card slot
- › Front panel OLED display
- › Front panel capacitive touch navigation
- › Front panel control of individual and chassis-wide mutes/levels (defeatable)
- › Rack mountable (2RU)
- › CE marked, UL listed, and RoHS compliant
- › Covered by Biamp Systems' five-year warranty

TESIRA AMP-8175R

The Tesira AMP-8175R is an eight channel digital networked amplifier. It is AVB/TSN enabled and delivers 175 watts per channel. It is rack mountable, and part of an integrated Tesira audio network. It also offers fault reporting, impedance monitoring, and optional analog failover.

- › Eight channels; 175W per channel
- › Impedance monitoring
- › Configurable via Tesira software
- › Dual AVB ports
- › Bridgeable channels
- › Optional analog failover
- › Optional I/O expander card slots
- › Front panel OLED display
- › Front panel capacitive touch navigation
- › Front panel control of individual and chassis-wide mutes/levels (defeatable)
- › Rack mountable (2RU)
- › CE marked, UL listed, and RoHS compliant
- › Covered by Biamp Systems' five-year warranty

AMP-A460H

The AMP-A460H is a four channel amplifier delivering 60 watts per channel in a sleek, compact design. It is a half-rack, D-class amplifier that operates in near silence with no need for internal cooling fans. It ships with a rack mounting kit for a single unit installation or mounting two units side-by-side.

- › Four channels; 60W per channel
- › Bridgeable channels
- › D-Class amplifier topology
- › Three manual switches provide: constant voltage operation, bridging channels, and a high-pass filter option
- › Supports both 70V and 100V Constant Voltage Systems
- › LED indicators for each output channel
- › Rack mountable; includes mounting kit
- › No additional software needed
- › CE marked, UL listed, and RoHS compliant
- › Covered by Biamp Systems' five-year warranty

ENDPOINTS

ENDPOINT EXPANDER CARDS

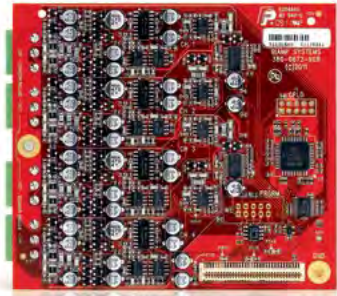

TESIRA EIC-4

The Tesira EIC-4 expander card is an optional card that can be installed in the Tesira EX-MOD and all Tesira amplifiers. Each EIC-4 provides four channels of mic or line level audio input. The inputs are electrically balanced and provided on plug-in barrier strip connectors. Software control of each input includes gain with clip indicator, +48V phantom power, mute, level, and signal invert.

- › Four channels of balanced mic or line level input
- › Plug-in barrier strip connectors
- › 0 – 66dB gain, adjustable in 6dB increments
- › Clip indicator
- › +48V Phantom Power
- › -100dB to +12dB fader range for level
- › Signal invert for reverse polarity
- › RoHS compliant and AES grounded
- › Covered by Biamp Systems' five-year warranty

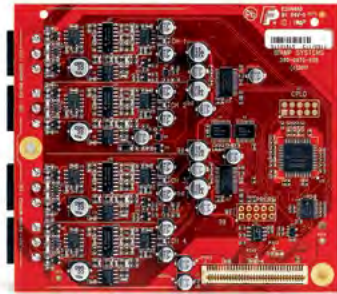

TESIRA EOC-4

The Tesira EOC-4 expander card is an optional card that can be installed in the Tesira EX-MOD and all Tesira amplifiers. Each EOC-4 provides four channels of mic or line level audio output. The outputs are electrically balanced and provided on plug-in barrier strip connectors. Software control of each output includes mute, level, signal invert, and full-scale output reference.

- › Four channels of balanced mic or line level output
- › Plug-in barrier strip connectors
- › -100dB to +12dB fader range for level
- › Signal invert for reverse polarity
- › Selectable full-scale output reference level (24dBu, 18dBu, 12dBu, 6dBu, 0dBu, -31dBu) for best interface/performance
- › RoHS compliant and AES grounded
- › Covered by Biamp Systems' five-year warranty

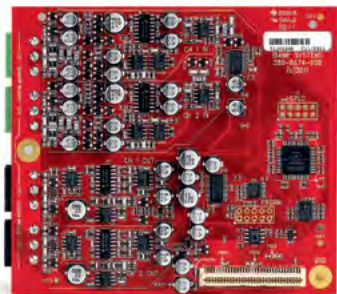

TESIRA EIOC-4

The Tesira EIOC-4 expander card is an optional card that can be installed in the Tesira EX-MOD and all Tesira amplifiers. Each EIOC-4 provides two channels of mic or line level audio input and two channels of mic or line level audio output. The inputs and outputs are electrically balanced and provided on plug-in barrier strip connectors. Software control of each input includes gain with clip indicator, +48V phantom power, mute, level, and signal invert; whereas control for each output includes mute, level, signal invert, and full-scale output reference.

- › Two channels of balanced mic or line level input
- › Two channels of balanced mic or line level output
- › 0 – 66dB gain, adjustable in 6dB increments on inputs
- › +48V Phantom Power on inputs
- › Selectable full-scale output reference level (24dBu, 18dBu, 12dBu, 6dBu, 0dBu, -31dBu) for best interface/performance
- › RoHS compliant and AES grounded
- › Covered by Biamp Systems' five-year warranty



EXPANDERS

TESIRA EX-IN



The Tesira EX-IN is a half-rack expander box for use with AVB-enabled Tesira server-class devices. The EX-IN is a 4-channel mic or line level audio input expander. The expander communicates with the Tesira AVB network for audio networking, configuration, and control, and is powered by PoE+.

- › Four channels of balanced mic or line level input
- › 0 – 66dB gain, adjustable in 6dB increments
- › +48V Phantom Power
- › -100 to +12dB fader range for level
- › Audio and control networking over AVB/TSN
- › Powered by PoE+
- › Plug-in barrier strip connectors
- › Front panel LEDs for device status indications
- › Half-rack chassis
- › RoHS compliant and AES grounded
- › Covered by Biamp Systems' five-year warranty

TESIRA EX-OUT



The Tesira EX-OUT is a half-rack expander box for use with AVB-enabled Tesira server-class devices. The EX-OUT is a 4-channel mic or line level audio output expander. The expander communicates with the Tesira AVB network for audio networking, configuration, and control, and is powered by PoE+.

- › Four channels of balanced mic or line level output
- › -100 to +12dB fader range for level
- › Signal invert for reverse polarity
- › Selectable full-scale output reference level (24dBu, 18dBu, 12dBu, 6dBu, 0dBu, -31dBu) for best interface/performance
- › Audio and control networking over AVB/TSN
- › Powered by PoE+
- › Plug-in barrier strip connectors
- › Front panel LEDs for device status indications
- › Half-rack chassis
- › RoHS compliant and AES grounded
- › Covered by Biamp Systems' five-year warranty

TESIRA EX-AEC



The Tesira EX-AEC is a half-rack expander box for use with AVB-enabled Tesira server-class devices. The EX-AEC is a 4-channel mic or line level audio input expander with AEC (Acoustic Echo Cancellation). The expander communicates with the Tesira AVB network for audio networking, configuration, and control, and is powered by PoE+.

- › Four channels of balanced mic or line level input with AEC (Acoustic Echo Cancellation)
- › 0 – 66dB gain, adjustable in 6dB increments
- › +48V Phantom Power
- › -100 to +12dB fader range for level
- › Audio and control networking over AVB/TSN
- › Powered by PoE+
- › Plug-in barrier strip connectors
- › Front panel LEDs for device status indications
- › Half-rack chassis
- › RoHS compliant and AES grounded
- › Covered by Biamp Systems' five-year warranty

TESIRA EX-IO



The Tesira EX-IO is a half-rack expander box for use with AVB-enabled Tesira server-class devices. The EX-IO is a 4-channel input and output expander. The expander features two channels of mic or line level audio input and two channels of mic or line level audio output. The expander communicates with the Tesira AVB network for audio networking, configuration, and control, and is powered by PoE+.

- › Two channels of balanced mic or line level input
- › Two channels of balanced mic or line level output
- › 0 – 66dB gain, adjustable in 6dB increments on inputs
- › Selectable full-scale output reference level (24dBu, 18dBu, 12dBu, 6dBu, 0dBu, -31dBu) for best interface/performance
- › +48V Phantom Power on inputs
- › Powered by PoE+
- › Half-rack chassis
- › RoHS compliant and AES grounded
- › Covered by Biamp Systems' five-year warranty



TESIRA EX-MOD

The Tesira EX-MOD is a modular expander device that is designed for use with AVB-enabled Tesira server-class devices. It can be configured with up to three 4-channel input and/or output cards for a maximum of 12 channels. The expander communicates with the Tesira AVB network for audio networking, configuration, and control.

- › Can be configured with up to three I/O cards
- › Up to 12 channels of analog audio
- › AVB/TSN connection to Tesira system for audio networking, configuration and control
- › Plug-in barrier strip connections on cards
- › Front panel LEDs for device status indications
- › Internal universal power supply
- › Rack mountable (1RU)
- › CE marked, UL listed, RoHS compliant
- › Covered by Biamp Systems' five-year warranty



EXPANDERS

EX-MOD EXPANDER CARDS

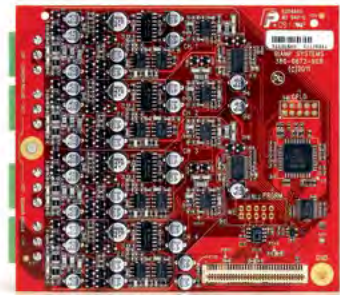

TESIRA EIC-4

The Tesira EIC-4 expander card is an optional card that can be installed in the Tesira EX-MOD and all Tesira amplifiers. Each EIC-4 provides four channels of mic or line level audio input. The inputs are electrically balanced and provided on plug-in barrier strip connectors. Software control of each input includes gain with clip indicator, +48V phantom power, mute, level, and signal invert.

- › Four channels of balanced mic or line level input
- › Plug-in barrier strip connectors
- › 0 – 66dB gain, adjustable in 6dB increments
- › Clip indicator
- › +48V Phantom Power
- › -100dB to +12dB fader range for level
- › Signal invert for reverse polarity
- › RoHS compliant and AES grounded
- › Covered by Biamp Systems' five-year warranty



TESIRA EEC-4

The Tesira EEC-4 expander card is an optional card that can be installed in the Tesira EX-MOD. Each EEC-4 provides four channels of mic or line level audio input with AEC (Acoustic Echo Cancellation). The inputs are electrically balanced and provided on plug-in barrier strip connectors. Software control of each input includes gain with clip indicator, +48V phantom power, mute, level, and signal invert.

- › Four channels of balanced mic or line level input with AEC (Acoustic Echo Cancellation)
- › Plug-in barrier strip connectors
- › 0 – 66dB gain, adjustable in 6dB increments
- › Clip indicator
- › +48V Phantom Power
- › -100dB to +12dB fader range for level
- › Signal invert for reverse polarity
- › RoHS compliant and AES grounded
- › Covered by Biamp Systems' five-year warranty

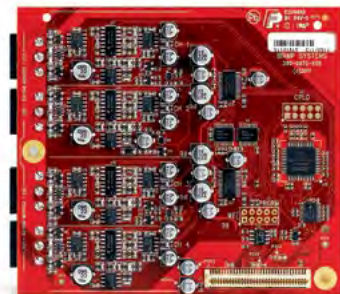

TESIRA EOC-4

The Tesira EOC-4 expander card is an optional card that can be installed in the Tesira EX-MOD and all Tesira amplifiers. Each EOC-4 provides four channels of mic or line level audio output. The outputs are electrically balanced and provided on plug-in barrier strip connectors. Software control of each output includes mute, level, signal invert, and full-scale output reference.

- › Four channels of balanced mic or line level output
- › Plug-in barrier strip connectors
- › -100dB to +12dB fader range for level
- › Signal invert for reverse polarity
- › Selectable full-scale output reference level (24dBu, 18dBu, 12dBu, 6dBu, 0dBu, -31dBu) for best interface/performance
- › RoHS compliant and AES grounded
- › Covered by Biamp Systems' five-year warranty

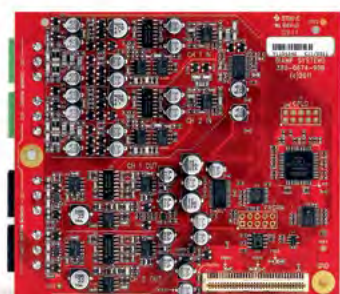

TESIRA EIOC-4

The Tesira EIOC-4 expander card is an optional card that can be installed in the Tesira EX-MOD and all Tesira amplifiers. Each EIOC-4 provides two channels of mic or line level audio input and two channels of mic or line level audio output. The inputs and outputs are electrically balanced and provided on plug-in barrier strip connectors. Software control of each input includes gain with clip indicator, +48V phantom power, mute, level, and signal invert; whereas control for each output includes mute, level, signal invert, and full-scale output reference.

- › Two channels of balanced mic or line level input
- › Two channels of balanced mic or line level output
- › 0 – 66dB gain, adjustable in 6dB increments on inputs
- › +48V Phantom Power on inputs
- › Selectable full-scale output reference level (24dBu, 18dBu, 12dBu, 6dBu, 0dBu, -31dBu) for best interface/performance
- › RoHS compliant and AES grounded
- › Covered by Biamp Systems' five-year warranty

MICROPHONES



CM1-6W • CM1-6WS

The CM1-6W and CM1-6WS are miniaturized condenser microphones with a fully integrated preamp designed with very high sensitivity for distance miking. They have complete immunity from RF interference caused by cell phones and GSM devices. A cardioid capsule (CM1-6W), or supercardioid capsule (CM1-6WS) is available, allowing these microphones to be used in a wide variety of applications.

- › High output for distance miking
- › Optimized for voice recognition
- › Immunity from RF interference
- › Operates on 18-52 volts phantom power
- › Point and shoot directivity
- › Miniaturized integrated preamp circuitry
- › No external power adapter needed
- › 12 mm gold vapor diaphragm
- › Extremely low noise, high sensitivity
- › Available with a cardioid or supercardioid capsule
- › Optional junction box available
- › Covered by three-year warranty

CONTROLS



The TEC-1s surface-mounts to any wall; multiple mounting options accommodate international back boxes



The TEC-1i flush-mounts to any wall; mounts using the retrofit plate (included) or installs in a Raco® 254 box for North American installations (not included)

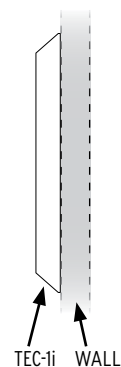

TESIRA TEC-1s • TESIRA TEC-1i

The Tesira TEC-1s and TEC-1i are Ethernet control devices for use with all Tesira and TesiraFORTÉ systems. Both devices offer a simple, intuitive interface for end users and can be installed and configured to fit the unique needs of a particular application. These devices connect via standard CAT-5/6/7 cabling and are powered over Ethernet, eliminating the need for custom cabling and local power sources. Multiple remote control panels can be connected over large distances using standard network technology.

The TEC-1s is surface-mounted while the TEC-1i can be flush-mounted into any wall.

- › Adjustment and/or initiation of 32 selectable system volumes and actions
- › Volumes are any individual or grouped system levels, including inputs, outputs, matrix cross-points, etc.
- › Actions are any individual or grouped system operations, including presets, source selection, mutes, ducking, combining, etc.
- › Control functions are programmed in the Tesira system design software
- › High contrast OLED display with a wide viewing angle
- › The display brightness can be adjusted to fit the ambient light present in the application and automatically dims when not in use
- › Capacitive touch technology eliminates protruding and moving parts to increase product reliability and longevity while simplifying cleaning
- › 330' (100m) Ethernet cable length can be extended with standard PoE network technology (routers, switches, hubs, media converters)
- › Connects with standard RJ-45 or IDC connector
- › Covered by Biamp Systems' five-year warranty

ORENO

Oreno is Biamp's mobile control software for Tesira-equipped rooms. Easy to use and simple to deploy, Oreno can run on nearly any mobile device, and requires minimal UI design work and no client software to be installed. Oreno has three core components: Oreno Creator, Oreno Manager, and the Oreno User Interface.

- › Pre-built UI templates
- › Soft dialer for POTS or VoIP systems
- › Audio level and mute controls
- › Optional user access control
- › Operates on any compatible web browser
- › Tesira preset recall
- › Audio meters
- › Oreno system event logging



TESIRA EX-LOGIC

The Tesira EX-LOGIC is a half-rack logic box for use with Tesira server-class devices. The EX-LOGIC provides both logic inputs and outputs and, through software, can be configured as a control interface. There are 16 total connections that can be used as inputs or outputs. 12 of the connections are designed as logic connections only and will accept contact closure or 5V TTL for input or provide a maximum of 40V/500mA for output. The remaining four connections can also be used for logic connections or as variable voltage control inputs (e.g. interface to a potentiometer). The EX-LOGIC also provides a serial port for the output of command strings that can be used to send action commands to other equipment in the system. The expander communicates with the Tesira AVB network for audio networking, configuration, and control, and is powered by PoE.



- › 16 total logic connections that can be used as inputs or outputs
- › 4 of the 16 connections can be used as voltage control inputs
- › Inputs can control actions within the software including: presets, mutes, ducking, room combining, paging functions, and much more
- › Outputs can trigger status relays or indicators, or provide logic input to other controllable equipment
- › Serial port for the output of command strings
- › Connects to Tesira server-class devices
- › Powered by PoE
- › Plug-in barrier strip connections
- › Front panel LEDs for device status indications
- › Half-rack chassis
- › RoHS compliant and AES grounded
- › Covered by Biamp Systems' five-year warranty

TESIRA HD-1

The Tesira HD-1 is a hardware dialer for Tesira server-class devices. The HD-1 is compatible with Tesira SERVER and SERVER-IO with STC-2 or SVC-2 cards installed, as well as TesiraFORTÉ TI, TesiraFORTÉ VI, TesiraFORTÉ AVB TI, and TesiraFORTÉ AVB VI devices.

- › Telephony control over Ethernet
- › LCD display
- › 12-button dial pad
- › 100 programmable speed dial numbers
- › 4 navigation buttons
- › Power over Ethernet (PoE)
- › Covered by Biamp Systems' five-year warranty



CONTROLS

BIAMP CANVAS

Biamp Canvas design and control software enables you to efficiently create and use customized control screens for the Tesira family of audio products. Biamp Canvas provides a flexible graphic control interface that can be tailored to meet the exact needs of the installation environment. With drag-and-drop functionality, you can place objects directly from the system design file into the software, creating pre-assigned control surfaces. We also added a variety of drawing tools to the software for customized graphic manipulation of controls, backgrounds, and labeling.

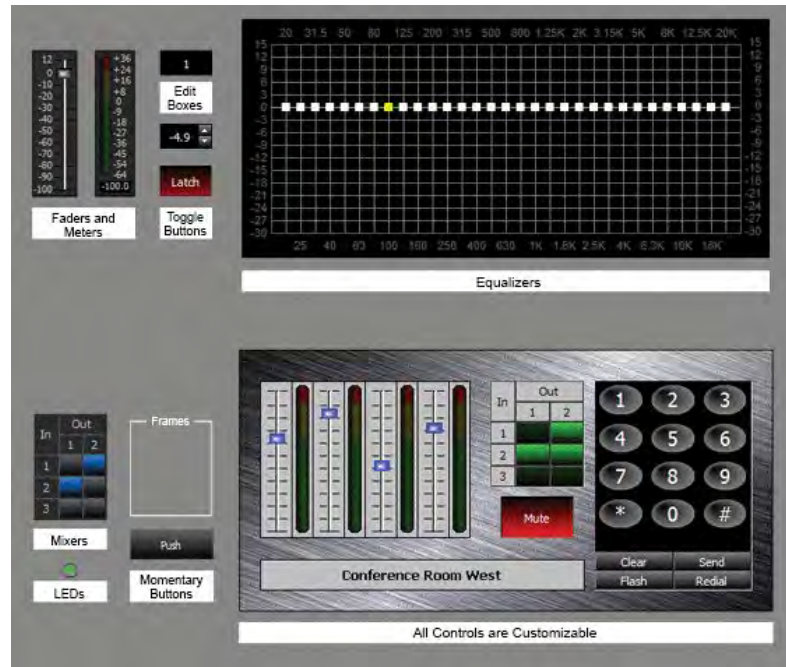

FEATURES

- › Create system control surfaces for PC/touch-screen
- › Place controls and assign them to system functions
- › Copy controls directly from system design objects
- › Customize control layout, function, and appearance
- › Control support for room combiners
- › Create/navigate multiple pages of operation
- › Restrict access to controls/pages via passwords
- › Works simultaneously with other system controls
- › Drag and drop programming
- › Update preset settings directly in Biamp Canvas

DESIGN SOFTWARE

TESIRA SOFTWARE

Tesira software is the interface for all system configurations. Creating the processing and system design for the application is done through a simple drag-and-drop interface. Toolbars allow control of processing, control, and diagnostic elements. Making audio and logic connections is fast and easy, and several options are available for displaying connection lines. System tools allow for easy device discovery and system configuration uploads.



FEATURES

- › Complete system configuration and control
- › Configuration engine confirms design, details hardware requirements for system
- › Partitions allow parts of the design to be kept separate from each other (although audio connections can be made between partitions)
- › Partitions compile separately, allowing unchanged partitions to stay online running while other partitions are changed, recompiled, and reloaded
- › A single partition can span multiple devices; a single device can have multiple partitions
- › New processing blocks; Über Filter and FIR Filter, Gain Sharing Automixer, Automatic Gain Control (AGC)
- › Many new line styles and features
- › Drag and drop creation and editing of presets
- › Logic Simulation
- › Enhanced Text Protocol includes data point monitoring
- › Selectable sample rates (48/96 kHz)

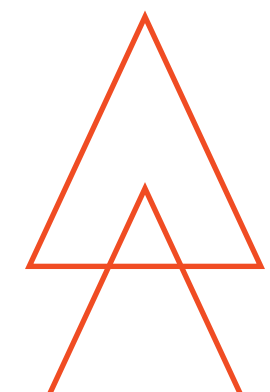

CONTACT US

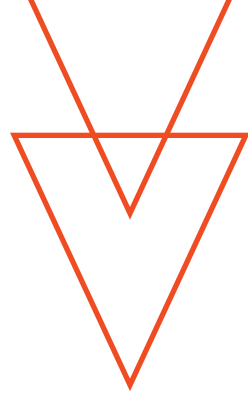

SUPPORT

When you need help, you don't want long hold times or confusing voicemail systems. That's why we've streamlined our support process and created a dedicated support phone number. You can reach our award-winning Support team 24 hours a day, from anywhere in the world. If you're located in the U.S. or Canada, dial 1-877-242-6796 (1-877-BIAMP-XO). If you're located elsewhere, we'd still love to hear from you. Call us at +1-503-718-9257.

Prefer to troubleshoot on your own? That's great too. Check out Cornerstone, our online technical support knowledgebase, at support.biamp.com. You'll find dozens of detailed articles designed to help you stay on track.

For training and how-to videos, visit the Biamp channel on YouTube. Our channel is optimized to help you quickly find what you're looking for. Trainings are organized by topic and we've crafted playlists to help you find groups of videos that pertain to a certain topic. Now, it's easier than ever to get the training and technical support you need from Biamp.

TRAINING

By understanding how to use Biamp products more effectively, you can build more efficient systems at a faster pace, allowing you to better manage time and resources by minimizing post-installation customer support costs. You'll network with other industry professionals and be able to build relationships with the teams that develop our products and provide support to customers.

We offer training courses all over the globe. Trainees can attend Tesira certification classes at our Beaverton, Oregon, headquarters, or at one of our three international Learning Centers. We also offer self-paced online training courses and webinars, including online certification courses for some of our product lines. To learn more about our training classes, visit biamp.com/training.

Biamp, Biamp Systems, Tesira, TesiraFORTÉ, TesiraLUX, Oreno, Audia, Nexia, Vocia, and Biamp Canvas are either trademarks or registered trademarks of Biamp Systems Corporation in the United States and other countries. HDMI, HDMI High-Definition Multimedia Interface, and the HDMI logo are either trademarks or registered trademarks of HDMI Licensing LLC in the United States and other countries. DisplayPort and the DisplayPort logo are trademarks owned by the Video Electronics Standards Association (VESA®) in the United States and other countries. Audinate and Dante are either trademarks or registered trademarks of Audinate Pty Ltd in the United States and other countries. Other product names referenced may be trademarks or registered marks of their respective owners and Biamp Systems is not affiliated with or sponsored by these companies.



To order product catalogs and other supporting literature, visit our Literature Ordering Link Online (LOLO). Go to www.biamp.com, click on account icon and look for the Order Literature (LOLO) link in the My Resources column.

Or, to inquire about orders contact: orders@biamp.com

Contact Support support@biamp.com

HEADQUARTERS

Biamp Systems
9300 S.W. Gemini Drive
Beaverton, OR 97008
+1.503.641.7287
800.826.1457 (US and Canada)

SALES

Ron Camden
Vice President,
Global Sales
ron.camden@biamp.com

MARKETING

Patrick Prothe
Marketing Communications Director
patrick.prothe@biamp.com

APPLICATIONS ENGINEERING

Kiley Henner
Director of Customer Experience
kiley.henner@biamp.com

Australia/New Zealand
anz@biamp.com

Europe East
europееast@biamp.com

Europe West
europewest@biamp.com

Europe Central
europеcentral@biamp.com

Greater China
greaterchina@biamp.com

Central America
centralamerica@biamp.com

South America
southamerica@biamp.com

Middle East & Africa
meafrica@biamp.com

India & SAARC Member Nations
saarc@biamp.com

Southeast Asia
seasia@biamp.com